



**SPECTRUM**  
INSTRUMENTS LTD.

# **IEPE (ICP) Sensor Checker SC-100**

User Manual

March 2016, Rev. 7.2

---

Please read carefully this manual before  
Operating the IEPE Sensor Checker SC-  
100

# Contents

<b>1</b>	<b>Product Description .....</b>	<b>4</b>
<b>2</b>	<b>SC-100 Map and Legend .....</b>	<b>5</b>
<b>3</b>	<b>Using SC-100 IEPE Sensor Checker .....</b>	<b>6</b>
	<b>3.1 IEPE (ICP<sup>®</sup>) SIGNAL GENERATOR Mode.....</b>	<b>7</b>
	<b>3.2 IEPE (ICP<sup>®</sup>) BOV TEST Mode .....</b>	<b>9</b>
<b>4</b>	<b>Battery Replacement.....</b>	<b>13</b>
<b>5</b>	<b>Dimensions .....</b>	<b>14</b>
	<b>Notices .....</b>	<b>15</b>

# 1 Product Description

SC-100 IEPE Sensor Checker is a battery operated, easy to use instrument for checking sensor condition and cabling by measuring Bias Output Voltage (BOV) of the sensor, and also for electronic simulation of the IEPE sensor output.

SC-100 is powered from one internally mounted 9V alkaline battery. There is also a LED (Light Emitting Diode) indication of LOW battery.

Operational mode can be selected by a slide switch mounted on the left side. There are also visual indicators of selected modes placed on the front panel. When the slide switch is in its middle position the device is OFF.

In BOV TEST mode, the user can read the measured BOV on the screen and observe the sensor status indicated by LEDs on the front panel. There are three predefined sensor statuses depending on the measured BOV: SHORT CIRCUIT, SENSOR OK and OPEN CIRCUIT.

In SIGNAL GENERATOR mode, SC-100 produces fixed frequency sinusoidal signal output to simulate IEPE (ICP<sup>®</sup>) accelerometer or velocity sensor.

## Specifications

### Connectors

BOV Input	BOV TEST Input, IEPE (ICP <sup>®</sup> ) Bias Output Voltage
Signal Output	SIGNAL GENERATOR Output, IEPE (ICP <sup>®</sup> ), current sinking

### Signal Generation

Amplitude	100mV RMS, sinusoidal
Amplitude Accuracy	≤1.0 %
Frequency	160.0 Hz
Frequency Accuracy	≤1.0 %
THD	≤1.0 %

### Environmental Features

Temperature	
Operating	-10°C to +65°C
Storage	-18°C to +65°C
Humidity	95% R.H. maximum

### Power

Battery	1 x 9V Alkaline (6LR61) Battery
---------	---------------------------------

### Physical Features

Dimension	150 mm x 80 mm x 30 mm
Weight	0.5kg typical
Case	Molded Plastic Case
Connection	BNC Connector

## 2 SC-100 Map and Legend

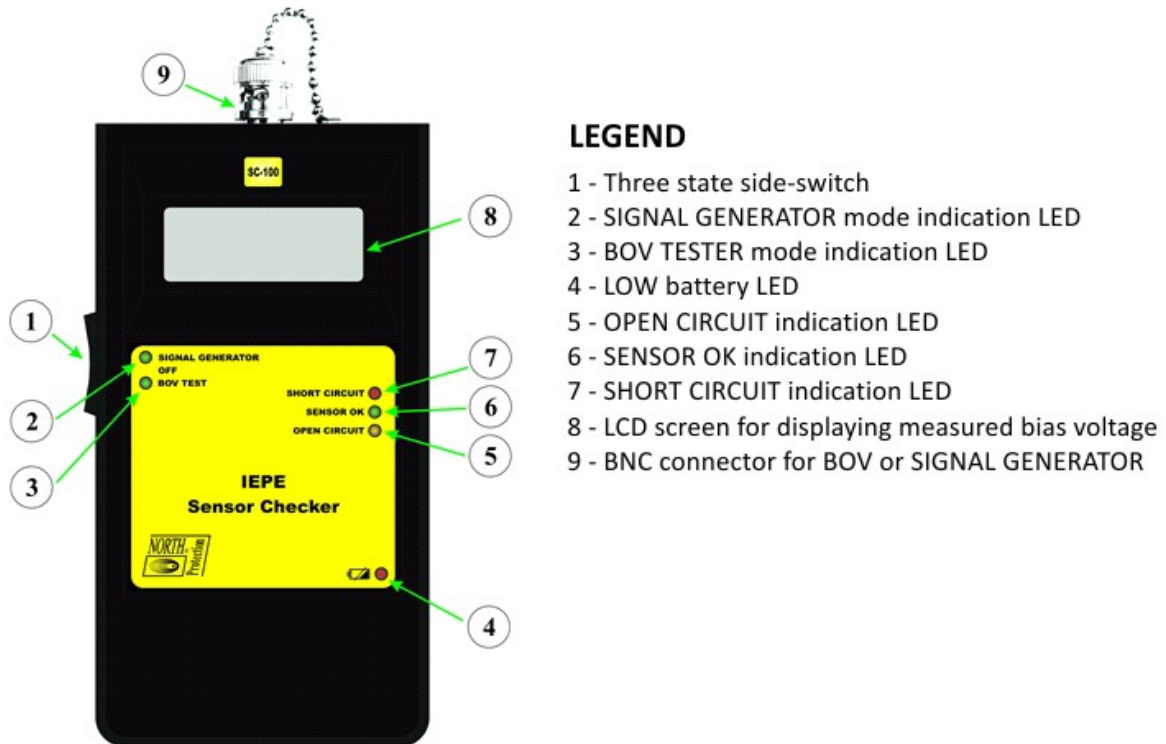

*Figure 1: Legend of SC-100 IEPE Sensor Checker*

### 3 Using SC-100 IEPE Sensor Checker

Selection of the operating modes is done by a slide switch mounted on the left side of the device. The front panel consists of six indicating LEDs. Two LEDs placed on the upper left side indicate the operating mode of the device. The upper LED displays SIGNAL GENERATOR mode, while the lower one shows BOV TEST mode. When the device is off, both LEDs are off. Three LEDs placed on the upper right side represent the statuses during BOV TEST. The possible statuses are: SHORT CIRCUIT, SENSOR OK and OPEN CIRCUIT. The LED on the bottom right is the empty battery indicator and the battery should be replaced when this LED is lit up.

There is also an LCD screen which displays measured BOV in Volts, when SC-100 operates in BOV TEST mode.



*Figure 2: Empty Battery Notification*

### 3.1 IEPE (ICP<sup>®</sup>) SIGNAL GENERATOR Mode

SIGNAL GENERATOR mode is activated by placing the slide switch in its upper position. In this operating mode, SC-100 produces the sinusoidal voltage signal of 100mV RMS at 160 Hz on its output. The LCD screen is off, and only the LED which indicates the operating mode is lit. These output values (voltage and frequency) are fixed. They are selected based on a standard for industrial accelerometer with

sensitivity of 100mV/g in order to produce 1g RMS readout on the instrument which is checked. Below a table with converted values for testing different types of vibration sensor.

Considering this, the user can also re-calculate the new values based on different sensitivities of the sensor (please see table below).

160Hz		
Units	RMS	Peak
mV	100.00	141.40
m/s <sup>2</sup>	9.81	13.87
g	1.00	1.41
mm/s	9.75	13.79
ips	0.38	0.54

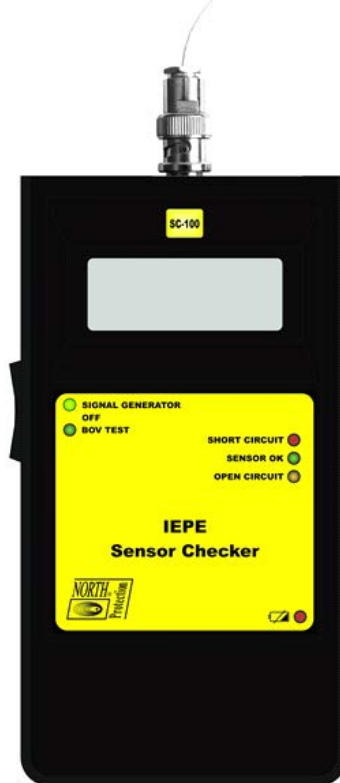

Figure 3: SIGNAL GENERATOR Mode

## Application Notes

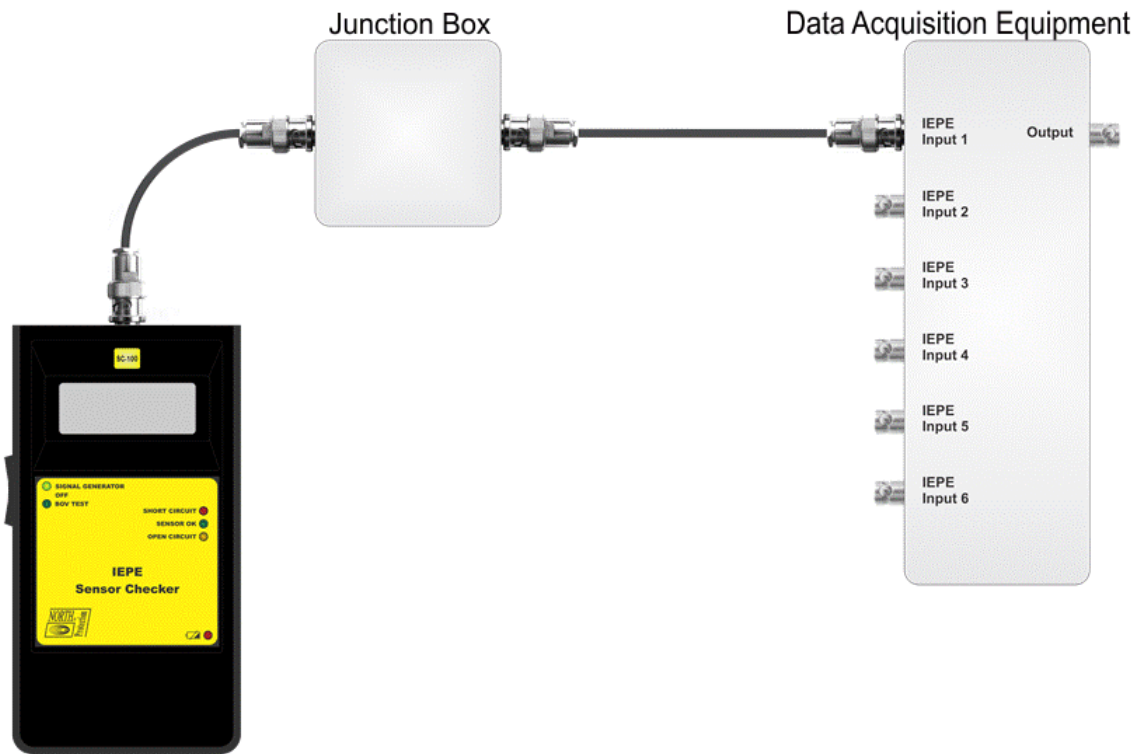

Figure 4: SIGNAL GENERATOR mode – CMS/DCS IEPE (ICP®) Inputs Checking



Figure 5: SIGNAL GENERATOR Mode – Vibration Meter IEPE (ICP®) Input Checking



### 3.2 IEPE (ICP<sup>®</sup>) BOV TEST Mode

BOV TEST mode is activated by placing the slide switch in its lower position. In this operating mode, IEPE Sensor Checker can be used for testing functionality and condition of IEPE sensors, and also to test sensor cabling. This is done by measuring Bias Output Voltage (BOV) of the connected sensor during its powering by SC-100 IEPE Sensor Checker (24VDC,  $I_{const.} = 3mA$ ). BNC connector is used to connect the sensor under test. This checker is suitable for checking BOV for all sensors which support IEPE (ICP<sup>®</sup>) standard. Measured BOV is displayed on the LCD display. The sensor status is visually displayed by three LEDs placed on the front panel. Possible states are: SHORT CIRCUIT, SENSOR OK and OPEN CIRCUIT.

If measured BOV is below 7V, SHORT CIRCUIT LED (Red LED) is lit. BOV readings below 7V usually indicate sensor damage. Common sources of sensors damage are: exposure to excessive temperature, excessive shock, electrostatic discharge or damaged amplifier. If the measured BOV is near 0V, this indicates a short connection in the sensor cable.

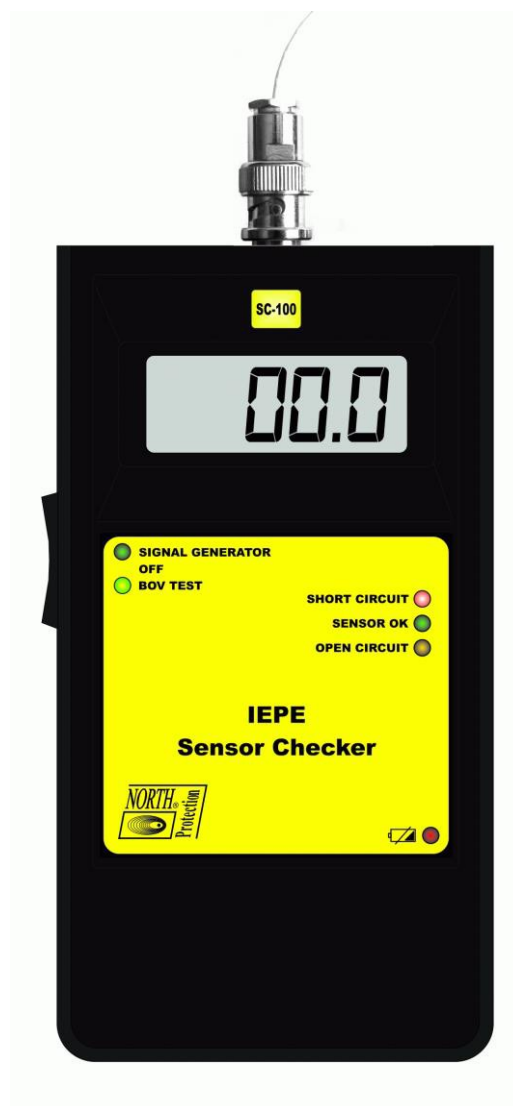

*Figure 6: Short Circuit Indication*

If measured BOV is below 15V and greater than 7V, SENSOR OK LED (Green LED) is lit. This usually means the sensor is in good condition. It is recommended to check documentation for nominal BOV for the tested sensor.



*Figure 7: Good Bias Voltage Indication*

If measured BOV is greater than 15V, OPEN CIRCUIT LED (Yellow LED) is lit up. This usually means that the sensor amplifier is not powered. In most cases, the problem is in the sensor connector or sensor cabling.



*Figure 8: High Bias Voltage Indication*

## Application Notes



Figure 9: BOV TEST Mode, - IEPE (ICP<sup>®</sup>) Sensor Checking

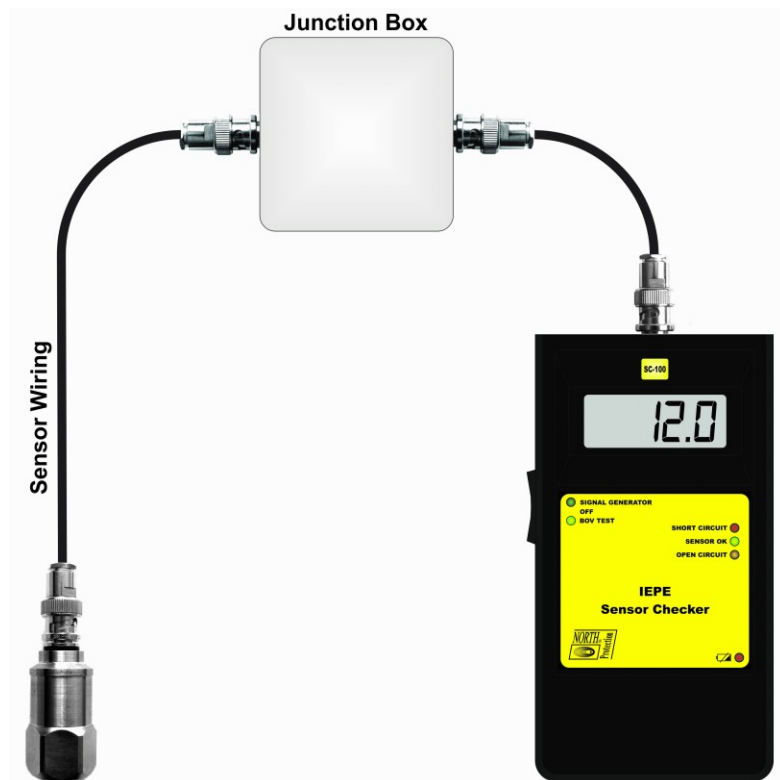
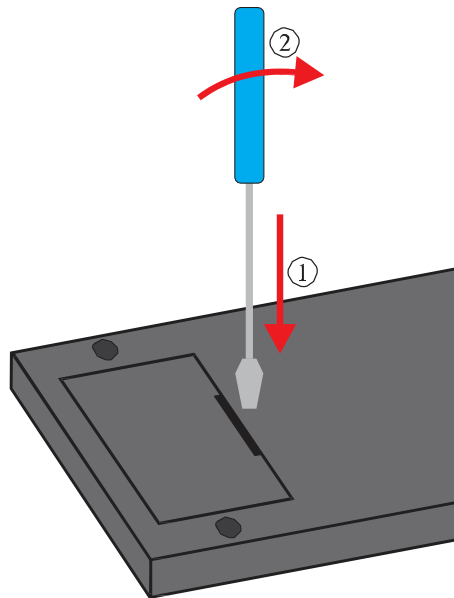

Figure 10: BOV TEST Mode - Wiring Checking

## 4 Battery Replacement

If the Empty Battery LED is lit, the battery should be replaced. Battery can be changed by opening a battery compartment located on the back side of the instrument.



*Figure 11: Battery Replacement*

For this operation, a flat screwdriver is needed. First, put the screwdriver in a back door opening hole. After that, gently pull a screwdriver to the front of the instrument and the Door should be opened. Take out the old battery and replace it with the new 9V alkaline battery (6LR61). Place a battery in such a way that there is no tension on the battery wires. Put the door back in its place and gently push it back. The SC-100 is ready for use again.

## 5 Dimensions

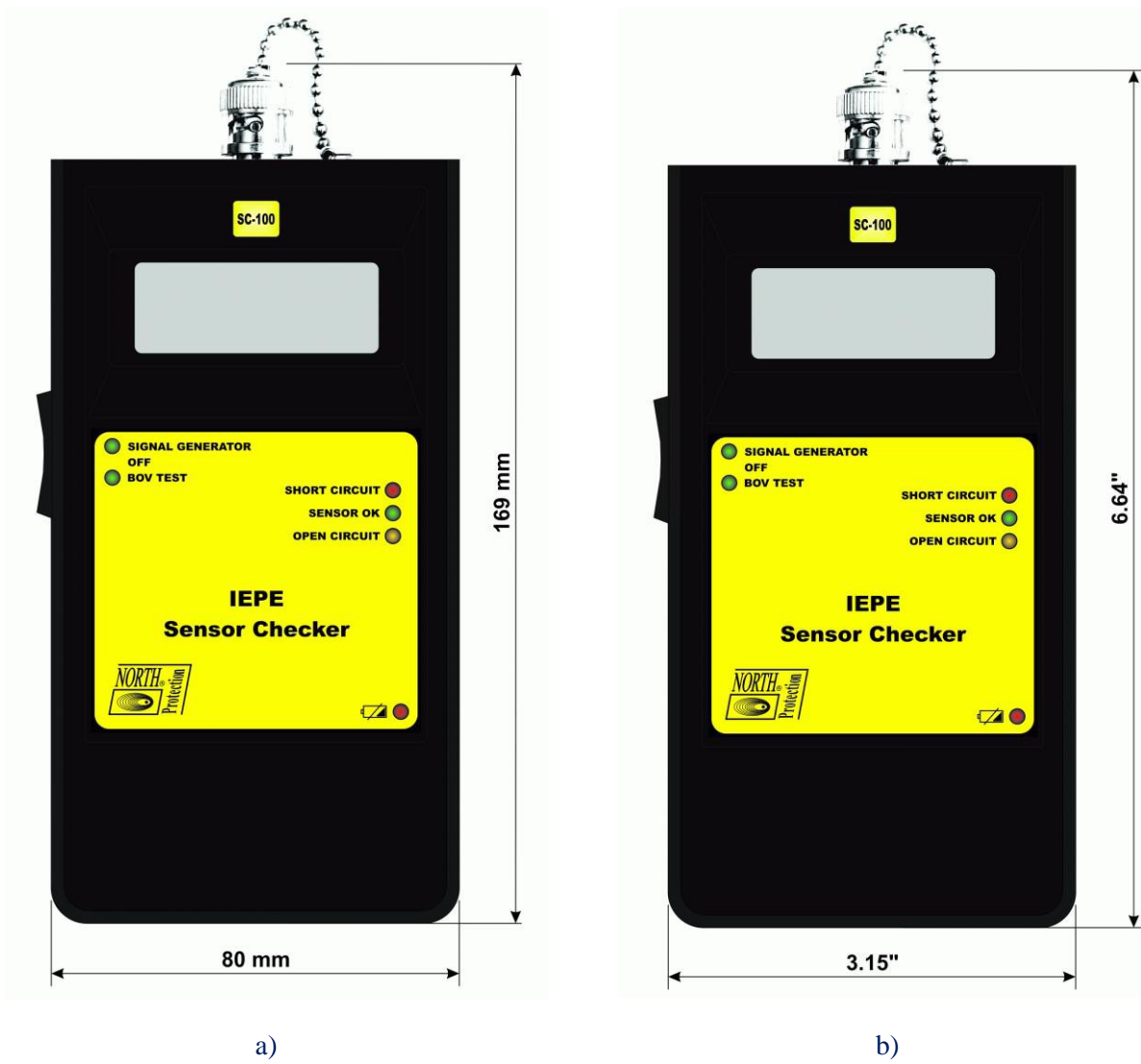

Figure 12: Device Dimensions - a) in millimeters, b) in inches

# Notices