



SI-510 DUAL TRIP AMPLIFIER
WITH ISOLATED
RE-TRANSMITTED OUTPUT



CONTENTS

1.	OVERVIEW	3
1.1	Product Identification	3
1.2	Standard SI-510 Modules	4
2.	SI-510 FUNCTIONS	4
2.1	Display	4
2.2	Relays & LEDs	4
2.3	Alarm Levels Settings	5
2.4	Alarm Delays	5
2.5	Alarm Relay Latching	5
2.6	Re-Transmitted Output	5
3.	INSTALLATION NOTES	5
3.1	General	5
3.2	Signal Pick-up	6
3.3	Ground Loops	6
4.	CONNECTION DETAILS	6
5.	RE-CONFIGURING THE SI-510 FUNCTIONS	13
5.1	Set Point Menu	13
5.2	Main Menu	13
5.3	Menu 3 & 4 - RELAY1 & RELAY2	14
5.4	Menu 5 & 6 - LED 1 & LED 2	15
5.5	Menu 7 & 8 – OUTPUT SPAN & OUTPUT ZERO	15
5.6	Menu 9 – INPUT UNITS	16
5.7	Menu 10 – RELAY TEST	16
5.8	Menu 11 & 12 – INPUT SPAN & INPUT ZERO	16
5.9	Menu 13 & 14 - HYS1 & HYS2	16
5.10	Menu 15 – OUTPUT OPTIONS	16
5.11	Menu 16 – POWER ON DELAY	17
5.12	Menu 17 & 20 - OFF TO ON DELAY1& OFF TO ON 2 DELAY2	17
5.13	Menu 18 & 21 - ON TO OFF DELAY1 & ON TO OFF DELAY2	18
5.14	Menu 19 & 22 – ON DELAY1 & ON DELAY2	18
6.	RE-CONFIGURING THE INPUT AND OUTPUT	19
6.1	Set Voltage Input:	20
3.3	Set Current Input	21
6.2	SI-510 Error Messages	22
7.	SI-510 SPECIFICATIONS (@ 25°C)	23
8.	WARRANTY	24

1. OVERVIEW

The SI-510 series Dual Trip Amplifiers are versatile and highly configurable DIN rail mounting modules designed to provide fail-safe vibration or temperature monitoring and indication. A digital display, two alarm relays and an isolated, re-transmitted output for remote monitoring are provided. SI-510 module configuration and calibration is carried out at the factory to a level of accuracy exceeding the normal requirements of vibration monitoring systems. The modules operate from a 24Vdc or ac supply and are available in a number of standard configurations. Connections to the module are made via numbered screw terminals and connection details and default settings are shown in the following pages. For non-standard applications, full re-configuring information and specifications are also included.

1.1 Product Identification

The SI-510 modules are identified by a 14 digit code which defines the input, output, display and relay functions as shown below.

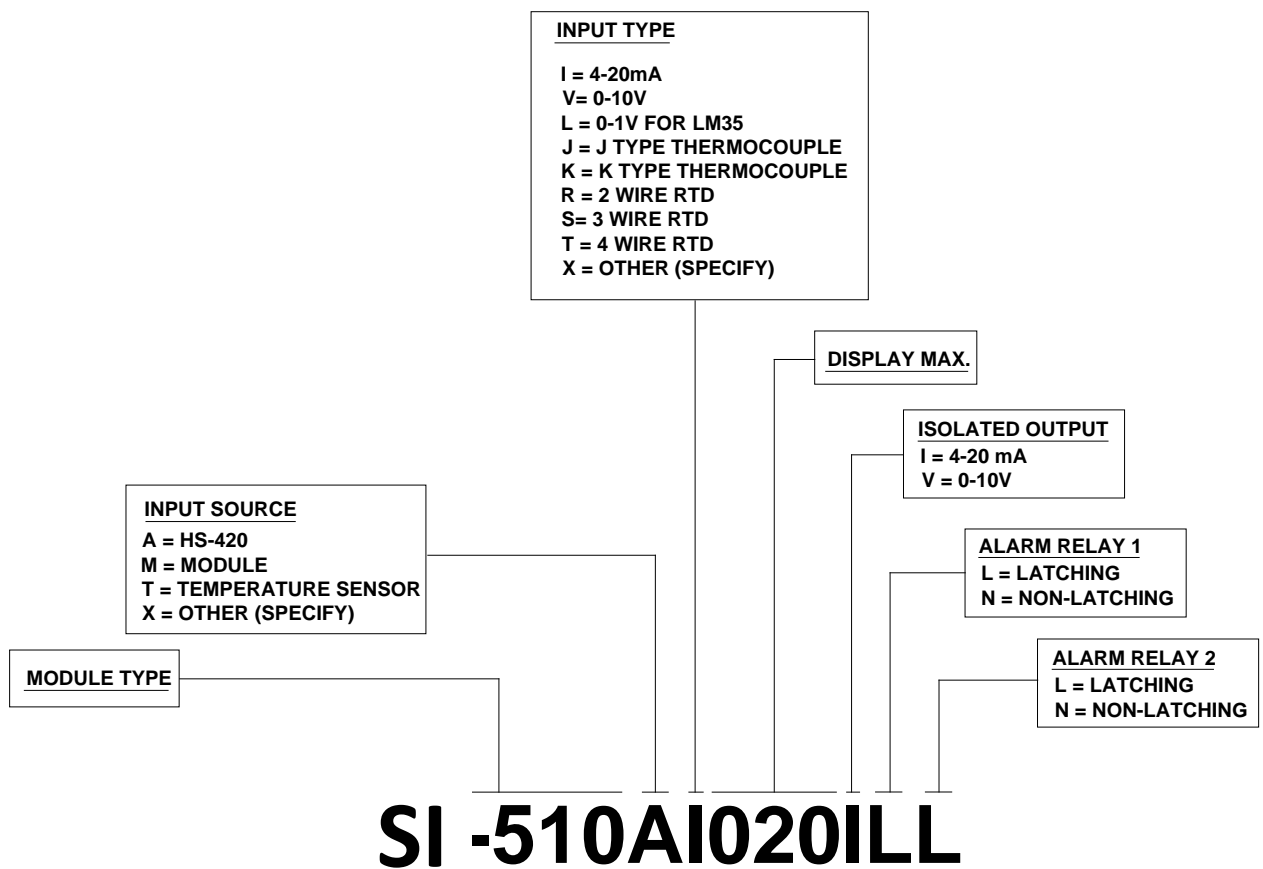

1.2 Standard SI-510 Modules

Several standard configurations are available as follows:-

- SI-510AI – For vibration monitoring using a directly connected SI-420 series 4-20mA sensor. The sensor is loop-powered from an isolated supply in the module. Connection details and default settings are shown on page 7.

- SI-510MI - For vibration monitoring using an SI-100 series constant current type sensor and a signal conditioning module such as an SI-535 or SI-556 having a 4-20mA output. Connection details and default settings are shown on page 8.

- SI-510MV - For vibration monitoring using an SI-100 series constant current type sensor and a signal conditioning module such as an HS-530 having a 0-10V output. Connection details and default settings are shown on page 9.

- SI-510TL - For temperature monitoring using a 10mV/°C temperature sensor as fitted in the SI-100T and SI-420 series accelerometers. Connection details and default settings for both sensors are shown on pages 10 and 11.

- SI-510TS - For temperature monitoring using Pt100 resistive temperature sensor. Connection details and default settings are shown page 12.

2. SI-510 FUNCTIONS

Many of the SI-510 functions are software controlled using the display and the 'Raise' and 'Lower' buttons on the front panel of the module. The control menus are at two levels. Level 1 is accessed by depressing both buttons for 2 seconds, and allows adjustment of the alarm levels only, as described in section 2.3. Level 2, the main menu, is accessed by sequence of button presses as in section 5.2. Input and output functions are set by internal switches as described in section 6.

2.1 Display

The SI-510 display is set to indicate the range of the sensor used eg. 0-25mm/s, 0-2g, 0-100°C, using the main menu functions 11. INPUT SPAN and 12. INPUT ZERO

2.2 Relays & LEDs

Alarm relays are set to be powered-on in the non-alarm condition for fail-safe operation. Lit LEDs will indicate an alarm condition. Main menu functions 3. RELAY 1 and 4. RELAY 2 and 5. LED 1 and 6. LED 2 are used to set these.

2.3 Alarm Levels Settings

The alarm level for RL1 (SP1) has been set nominally at 5 and for RL2 (SP2) at 10. The alarm levels can be easily changed on installation by using the front panel 'raise' and 'lower' buttons as follows:-

- (a) Depress and hold both 'raise' and 'lower' buttons together for at least 2 seconds until 'OK' is displayed.**
- (b) Select '1.SETPOINT1' or '2.SETPOINT2' on the display using either button.**
- (c) Press and release both buttons quickly to display the current setting.**
- (d) Adjust the setting using the 'raise' or 'lower' button.**
- (e) Depress and release both buttons quickly to return to the SETPOINT menu.**
- (f) Depress and hold both buttons for at least 2 seconds until 'OK' is displayed to return to the run mode.**

For changes to all other SI-510 settings it is necessary to enter the Main Menu using a sequence of button presses. Refer to section 5.2 for details.

2.4 Alarm Delays

To allow for excess vibration on start-up, a power on delay is set to 30 seconds, during which no alarms will operate. In addition both alarms are set with a 5 second delay such that the alarm conditions must be present for at least this time before the alarms operate. These are set using the main menu functions 16 to 22 as described in section 5.11 to 5.22.

2.5 Alarm Relay Latching

Both alarm relays are set to latch on operation and can be reset by depressing and releasing the 'Raise' and 'Lower' buttons together quickly. Relay latching is set via main menu functions 3 and 4 as shown in section 5.3.

2.6 Re-Transmitted Output

An isolated 4-20mA output for remote monitoring is available with connections as shown on the drawings overleaf. The output can be set to either a current or a voltage by the internal link S3 where the 'OFF' position is for current output and the 'ON' position for voltage output. A wide range of output options can be set eg. 4-20mA, 0 to 20mA, 0-10V, 1-5V etc. using S3 and the main menu functions 7 and 8. Section 5.5 describes the procedure.

3. INSTALLATION NOTES

3.1 General

The SI-510A's input and output circuits are classed as Separated Extra Low Voltage (SELV). This means that they must not be externally connected to voltages exceeding 30V ac or 60V dc, nor do they generate voltages above these limits internally. Where a higher voltage input is required a voltage divider circuit should be used to condition the input signal prior to connection to the input terminals.

The SI-510 unit clips directly onto 'Top Hat' (TS35) symmetrical DIN rail. Ideally, mounting orientation should be vertical. Good airflow around the unit will maximise reliability of the module.

The use of bootlace ferrules is recommended on wiring terminations.

Do not exceed terminal torque rating of 0.4 Nm – use an appropriate screwdriver. The unit can be removed from the DIN rail by sliding a small screwdriver into the slot at the rear of the enclosure on the lower face and gently levering the metal clip, whilst lifting the unit from the rail.

Connection details for SI-510 modules are shown in Section 4.

3.2 Signal Pick-up

In many industrial environments, the low amplitude signals generated by a vibration sensor can be corrupted by pick-up from nearby electric fields produced by motors, generators or speed control electronics. This can result in higher than expected vibration readings and careful attention to screening and grounding issues are necessary. To avoid signal pick-up, the requirement is that the accelerometer outer case should be connected via a continuous cable screen to the 0V of the power supply that provides the accelerometer power. This will prevent coupling of spurious signals, on the sensor case and wiring, into the measurement circuit. With the SI-420 and SI-510AI combination this is easily achieved by connecting the accelerometer screen wire to terminal 4 or 5.

3.3 Ground Loops

Ground loop problems occur when shielding conductors are grounded at physically different points. Large circulating currents in the loop can be created by changing magnetic fields within the loop. This causes potential differences, usually at 50Hz, at the supposedly grounded points which add to the vibration signal, resulting in incorrect readings. Ground loop effects are easy to avoid with the SI-510 since the input, output and power supply are electrically isolated. It is therefore safe to ground both the sensor case via the machine and the power supply 0V, without creating a loop. Where a machine casing is electrically 'noisy', it may be necessary to use an isolating mounting stud. In SI-420 sensors the outer case can then be connected to the measurement 0V via the screen wire. The intrinsically safe SI-420I series sensors, however, do not have the screen wire connected to case and other arrangements may need to be made. Due to the differences in local conditions the optimum grounding configuration for the vibration monitoring system will need to be established empirically on installation and commissioning.

4. CONNECTION DETAILS

The following pages show the connection details for a number of SI-510 variants for use with vibration sensors, temperature sensors, and signal conditioning modules.

HS-510AI CONNECTIONS

TERMINAL CONNECTIONS

- 18 - RELAY 2 CLOSE ON ALARM
- X - NO CONNECTION
- 15 - RELAY 2 OPEN ON ALARM
- 20 - RELAY 2 COMMON

- 15 - RELAY 1 CLOSE ON ALARM
- X - NO CONNECTION
- 16 - RELAY 1 OPEN ON ALARM
- 17 - RELAY 1 COMMON

- 2 - +24V POWER INPUT
- 1 - 0V POWER INPUT
- 10 - OUTPUT +mA
- 12 - OUTPUT -mA

- 5 - HS420 BLACK + SCREEN
- 4 - ALT. SCREEN CONNECTION
- 6 - DO NOT CONNECT

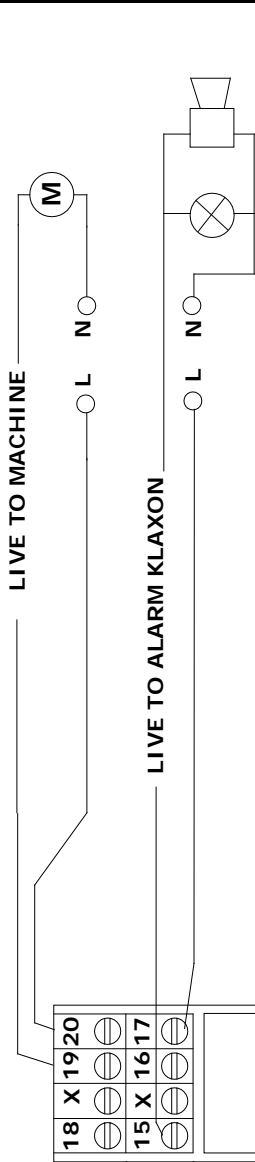

HS510V TRIP AMPLIFIER DEFAULT SETTINGS

- 1 - SETPOINT 1 = 5mm/s
- 2 - SETPOINT 2 = 10mm/s
- 3 - RELAY 1 = RL1 LATCH OFF ABOVE SP1
- 4 - RELAY 2 = RL2 LATCH OFF ABOVE SP2
- 5 - LED 1 = LED1 ON WHEN RL1 OFF
- 6 - LED 2 = LED2 ON WHEN RL2 OFF
- 7 - OUTPUT SPAN = 20.00
- 8 - OUTPUT ZERO = 4.00
- 9 - INPUT UNITS = BLANK 2 DP
- 10 - RELAY TEST = N/A
- 11 - INPUT SPAN = AS HS420 RANGE IN mm/s
- 12 - INPUT ZERO = 0 mm/s
- 13 - HYS 1 = 0.2mA
- 14 - HYS 2 = 0.2mA
- 15 - OUTPUT OPTIONS = AVERAGE ON
- 16 - POWER ON DELAY 1 = 30 SECONDS
- 17 - OFF TO ON DELAY 1 = 5 SECONDS
- 18 - ON TO OFF DELAY 1 = 0.5 SECONDS
- 19 - ON DELAY 1 = 0.5 SECONDS
- 20 - OFF TO ON DELAY 2 = 5 SECONDS
- 21 - ON TO OFF DELAY 2 = 0.5 SECONDS
- 22 - ON DELAY 2 = 0.5 SECONDS

OUTPUT TO
REMOTE MONITOR

+ mA

- mA

WHITE

BLACK
& SCREEN

+24V IN

0V IN

HS510V INTERNAL SETTINGS

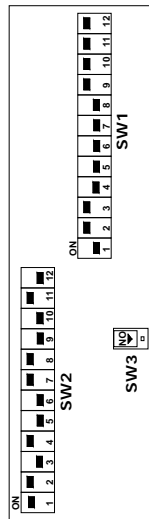

HS-510MI CONNECTIONS

TERMINAL CONNECTIONS

- 18 - RELAY 2 CLOSE ON ALARM
- X - NO CONNECTION
- 19 - RELAY 2 OPEN ON ALARM
- 20 - RELAY 2 COMMON

- 15 - RELAY 1 CLOSE ON ALARM
- X - NO CONNECTION
- 16 - RELAY 1 OPEN ON ALARM
- 17 - RELAY 1 COMMON

- 2 - +24V POWER INPUT
- 1 - 0V POWER INPUT
- 10 - OUTPUT -mA
- 12 - OUTPUT +mA

- 5 - +lin
- 4 - -lin
- 3 - DO NOT CONNECT
- 6 - DO NOT CONNECT

HS-510MI INTERNAL SETTINGS

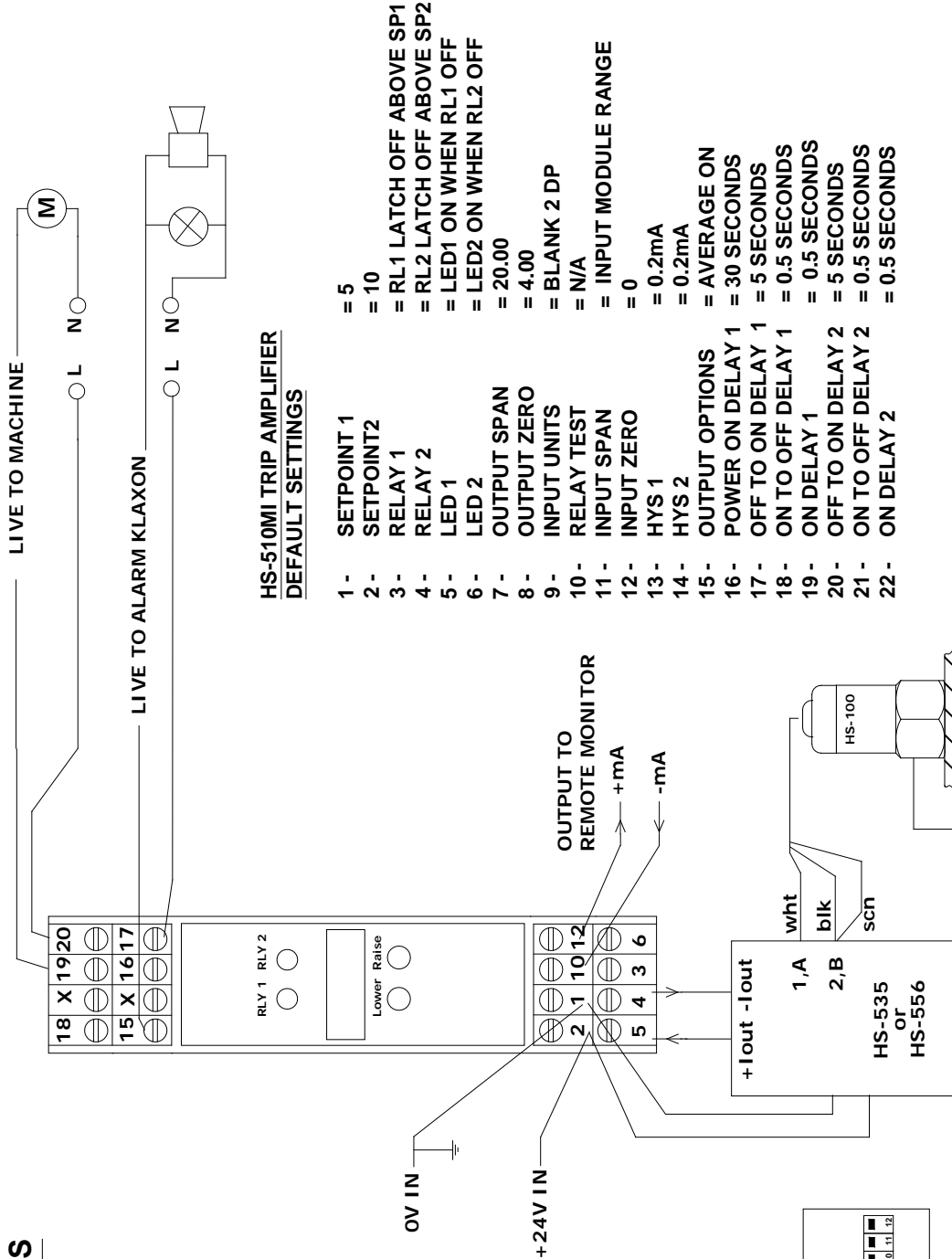
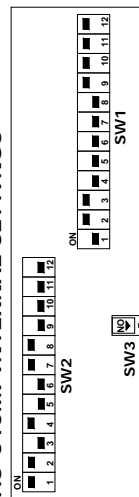

HS-510MI TRIP AMPLIFIER DEFAULT SETTINGS

- 1 - SETPOINT 1 = 5
- 2 - SETPOINT 2 = 10
- 3 - RELAY 1 = RL1 LATCH OFF ABOVE SP1
- 4 - RELAY 2 = RL2 LATCH OFF ABOVE SP2
- 5 - LED 1 = LED1 ON WHEN RL1 OFF
- 6 - LED 2 = LED2 ON WHEN RL2 OFF
- 7 - OUTPUT SPAN = 20.00
- 8 - OUTPUT ZERO = 4.00
- 9 - INPUT UNITS = BLANK 2 DP
- 10 - RELAY TEST = N/A
- 11 - INPUT SPAN = INPUT MODULE RANGE
- 12 - INPUT ZERO = 0
- 13 - HYS 1 = 0.2mA
- 14 - HYS 2 = 0.2mA
- 15 - OUTPUT OPTIONS = AVERAGE ON
- 16 - POWER ON DELAY 1 = 30 SECONDS
- 17 - OFF TO ON DELAY 1 = 5 SECONDS
- 18 - ON TO OFF DELAY 1 = 0.5 SECONDS
- 19 - ON DELAY 1 = 0.5 SECONDS
- 20 - OFF TO ON DELAY 2 = 5 SECONDS
- 21 - ON TO OFF DELAY 2 = 0.5 SECONDS
- 22 - ON DELAY 2 = 0.5 SECONDS

HS-510MV CONNECTIONS

TERMINAL CONNECTIONS

- 18 - RELAY 2 CLOSE ON ALARM
- X - NO CONNECTION
- 15 X 16 17
- 20 - RELAY 2 COMMON

- 15 - RELAY 1 CLOSE ON ALARM
- X - NO CONNECTION
- 16 - RELAY 1 OPEN ON ALARM
- 17 - RELAY 1 COMMON

- 2 - +24V POWER INPUT
- 1 - 0V POWER INPUT
- 10 - OUTPUT -mA
- 12 - OUTPUT +mA

- 5 - +Vin
- 4 - -Vin
- 3 - DO NOT CONNECT
- 6 - DO NOT CONNECT

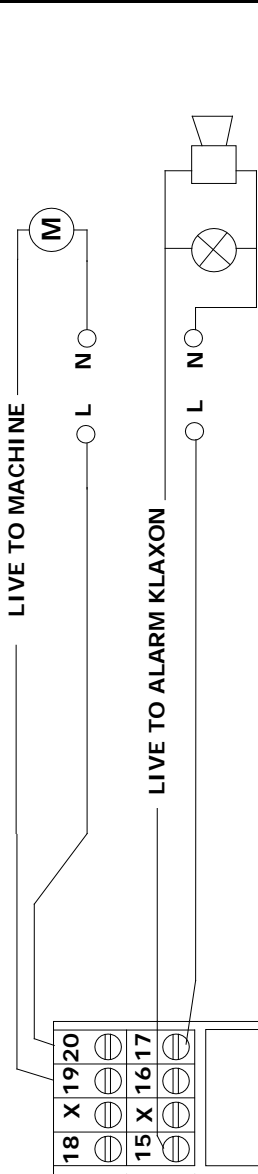

**HS-510MV TRIP AMPLIFIER
DEFAULT SETTINGS**

- 1 - SETPOINT 1 = 5
- 2 - SETPOINT 2 = 10
- 3 - RELAY 1 = RL1 LATCH OFF ABOVE SP1
- 4 - RELAY 2 = RL2 LATCH OFF ABOVE SP2
- 5 - LED 1 = LED1 ON WHEN RL1 OFF
- 6 - LED 2 = LED2 ON WHEN RL2 OFF
- 7 - OUTPUT SPAN = 20.00
- 8 - OUTPUT ZERO = 4.00
- 9 - INPUT UNITS = BLANK 2 DP
- 10 - RELAY TEST = N/A
- 11 - INPUT SPAN = AS INPUT MODULE RANGE
- 12 - INPUT ZERO = 0
- 13 - HYS 1 = 0.2V
- 14 - HYS 2 = 0.2V
- 15 - OUTPUT OPTIONS = AVERAGE ON
- 16 - POWER ON DELAY 1 = 30 SECONDS
- 17 - OFF TO ON DELAY 1 = 5 SECONDS
- 18 - ON TO OFF DELAY 1 = 0.5 SECONDS
- 19 - ON DELAY 1 = 0.5 SECONDS
- 20 - OFF TO ON DELAY 2 = 5 SECONDS
- 21 - ON TO OFF DELAY 2 = 0.5 SECONDS
- 22 - ON DELAY 2 = 0.5 SECONDS

OUTPUT TO
REMOTE MONITOR

+mA
-mA

+24V IN
0V IN

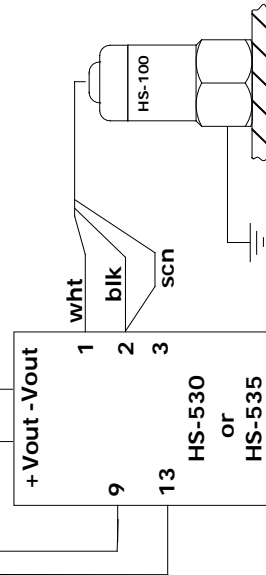

HS-510MV INTERNAL SETTINGS

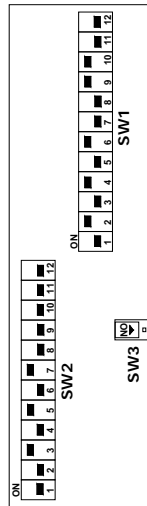

HS-510TL + HS-420T CONNECTIONS

TERMINAL CONNECTIONS

- 18 - RELAY 2 CLOSE ON ALARM
- X - NO CONNECTION
- 19 - RELAY2 OPEN ON ALARM
- 20 - RELAY 2 COMMON
- 15 - RELAY 1 CLOSE ON ALARM
- X - NO CONNECTION
- 16 - RELAY1 OPEN ON ALARM
- 17 - RELAY 1 COMMON

- 2 - +24V POWER INPUT
- 1 - 0V POWER INPUT
- 10 - OUTPUT -mA
- 12 - OUTPUT +mA

- 5 - +SIGNAL IN (Temp. Sensor Output)
- 4 - 0V IN (Temp. Sensor 0V)
- 3 - DO NOT CONNECT
- 6 - DO NOT CONNECT

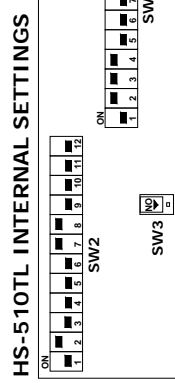
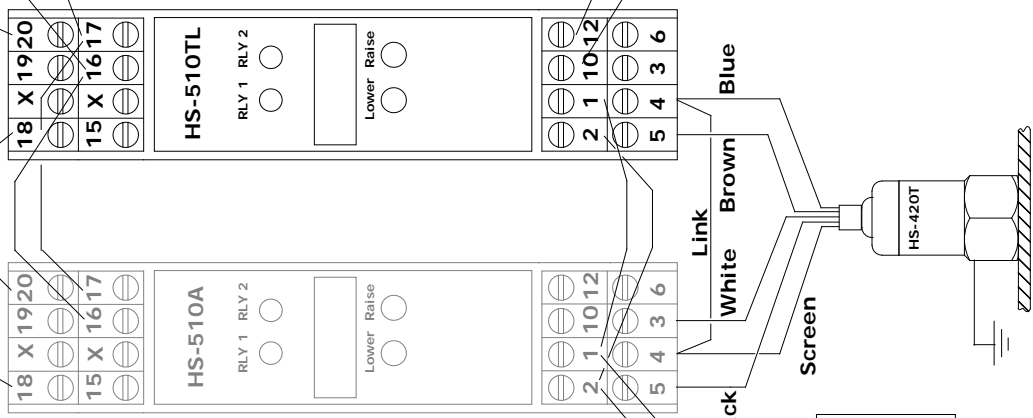
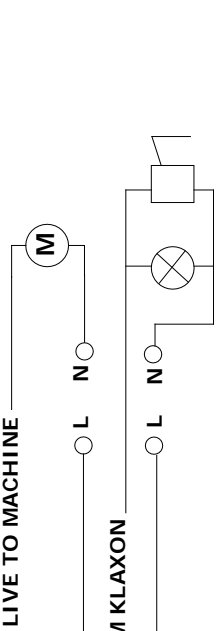

**HS-510TL TRIP AMPLIFIER
DEFAULT SETTINGS**

- 1 - SETPOINT 1 = 50 Deg.C
- 2 - SETPOINT2 = 80 Deg.C
- 3 - RELAY1 = RL1 LATCH OFF ABOVE SP1
- 4 - RELAY2 = RL2 LATCH OFF ABOVE SP2
- 5 - LED 1 = LED1 ON WHEN RL1 OFF
- 6 - LED 2 = LED2 ON WHEN RL2 OFF
- 7 - OUTPUT SPAN = 20.00
- 8 - OUTPUT ZERO = 4.00
- 9 - INPUT UNITS = Deg.C 1DP
- 10 - RELAY TEST = N/A
- 11 - INPUT SPAN = 100 Deg.C
- 12 - INPUT ZERO = 0 Deg.C
- 13 - HYS 1 = 0.2mA
- 14 - HYS 2 = 0.2mA
- 15 - OUTPUT OPTIONS = AVERAGE ON
- 16 - POWER ON DELAY 1 = 0.5 SECONDS
- 17 - OFF TO ON DELAY 1 = 5 SECONDS
- 18 - ON TO OFF DELAY 1 = 0.5 SECONDS
- 19 - ON DELAY 1 = 0.5 SECONDS
- 20 - OFF TO ON DELAY 2 = 5 SECONDS
- 21 - ON TO OFF DELAY 2 = 0.5 SECONDS
- 22 - ON DELAY 2 = 0.5 SECONDS

HS-510TL + HS-100T CONNECTIONS

TERMINAL CONNECTIONS

- 18 - RELAY 2 CLOSE ON ALARM
- X - NO CONNECTION
- 19 - RELAY2 OPEN ON ALARM
- 20 - RELAY 2 COMMON
- 15 - RELAY 1 CLOSE ON ALARM
- X - NO CONNECTION
- 16 - RELAY1 OPEN ON ALARM
- 17 - RELAY 1 COMMON

- 2 - +24V POWER INPUT
- 1 - 0V POWER INPUT
- 10 - OUTPUT -mA
- 12 - OUTPUT +mA

- 5 - +SIGNAL IN (Temp. Sensor Output)
- 4 - 0V IN (Temp. Sensor 0V)
- 3 - DO NOT CONNECT
- 6 - DO NOT CONNECT

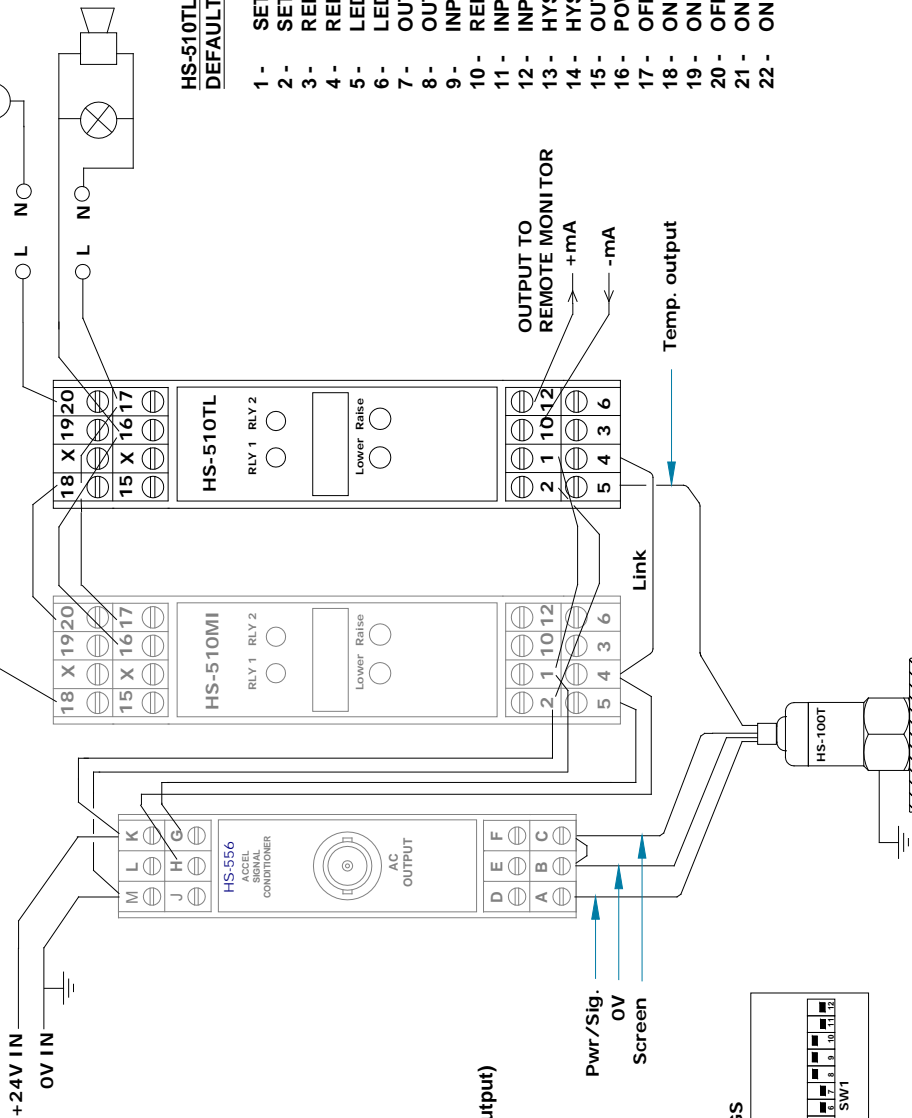

**HS-510TL TRIP AMPLIFIER
DEFAULT SETTINGS**

- 1 - SETPOINT 1 = 50 Deg.C
- 2 - SETPOINT2 = 80 Deg.C
- 3 - RELAY1 = RL1 LATCH OFF ABOVE SP1
- 4 - RELAY2 = RL2 LATCH OFF ABOVE SP2
- 5 - LED 1 = LED1 ON WHEN RL1 OFF
- 6 - LED 2 = LED2 ON WHEN RL2 OFF
- 7 - OUTPUT SPAN = 20.00
- 8 - OUTPUT ZERO = 4.00
- 9 - INPUT UNITS = Deg.C 1DP
- 10 - RELAY TEST = N/A
- 11 - INPUT SPAN = 100 Deg.C
- 12 - INPUT ZERO = 0 Deg.C
- 13 - HYS 1 = 0.2mA
- 14 - HYS 2 = 0.2mA
- 15 - OUTPUT OPTIONS = AVERAGE ON
- 16 - POWER ON DELAY 1 = 0.5 SECONDS
- 17 - OFF TO ON DELAY 1 = 5 SECONDS
- 18 - ON TO OFF DELAY 1 = 0.5 SECONDS
- 19 - ON DELAY 1 = 0.5 SECONDS
- 20 - OFF TO ON DELAY 2 = 5 SECONDS
- 21 - ON TO OFF DELAY 2 = 0.5 SECONDS
- 22 - ON DELAY 2 = 0.5 SECONDS

HS-510TL INTERNAL SETTINGS

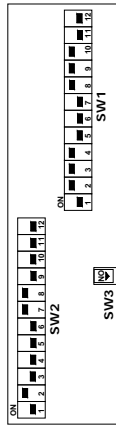

HS-510TS CONNECTIONS

TERMINAL CONNECTIONS

- 18 - RELAY 2 CLOSE ON ALARM
- X - NO CONNECTION
- 19 - RELAY 2 OPEN ON ALARM
- 20 - RELAY 2 COMMON

- 15 - RELAY 1 CLOSE ON ALARM
- X - NO CONNECTION
- 16 - RELAY 1 OPEN ON ALARM
- 17 - RELAY 1 COMMON

- 2 - +24V POWER INPUT
- 1 - 0V POWER INPUT
- 10 - OUTPUT -mA
- 12 - OUTPUT +mA

- 5 - RTD Sensor (2 wire)
- 4 - RTD Sensor (2 wire)
- 3 - RTD Sensor terminal 5 end (4 wire)
- 6 - RTD Sensor terminal 4 end (3&4 wire)

HS-510TS INTERNAL SETTINGS

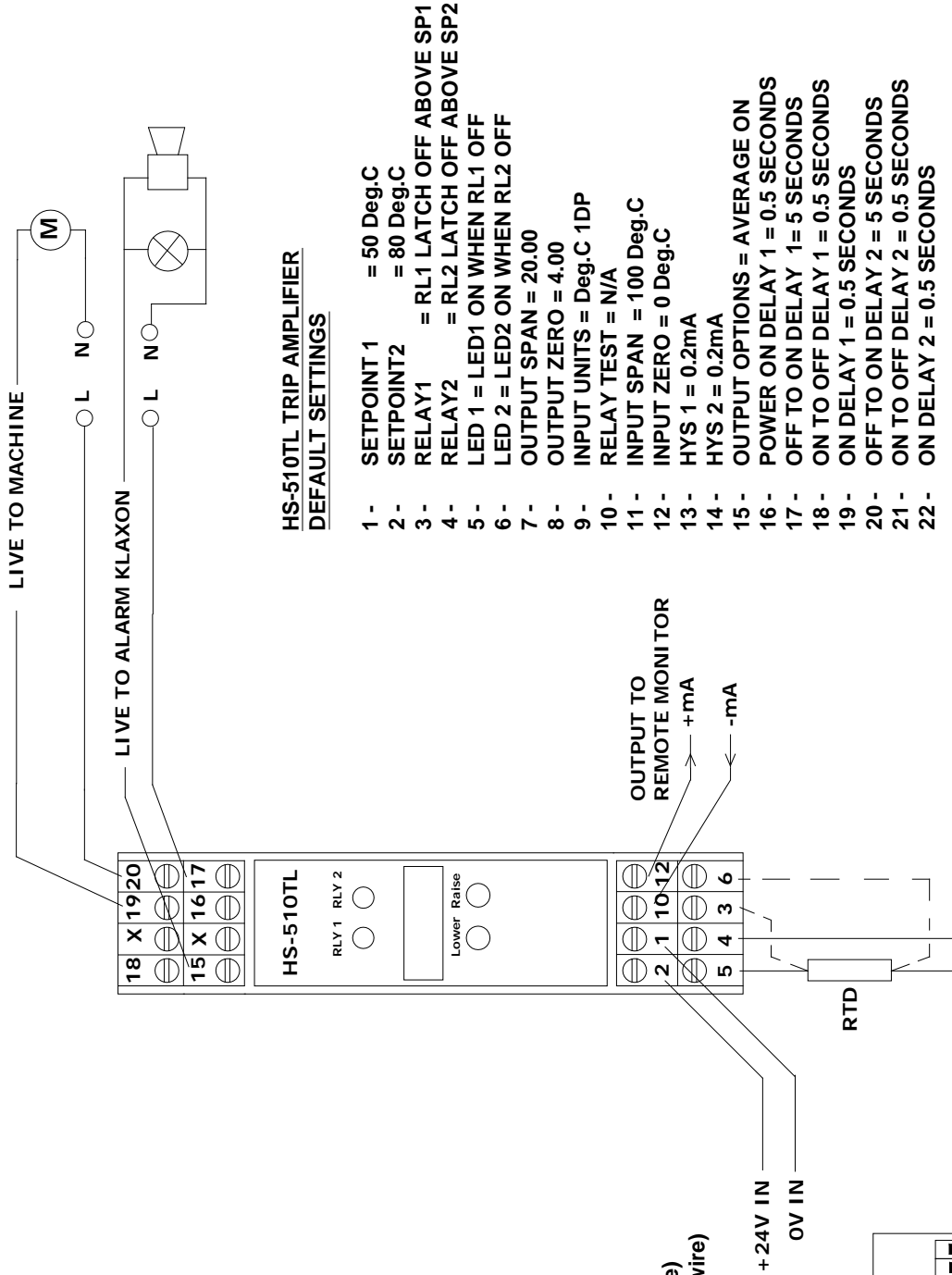
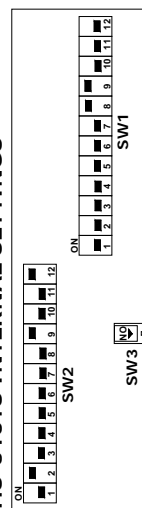

5. RE-CONFIGURING THE SI-510 FUNCTIONS

5.1 Set Point Menu

To access the set point menu push and hold both buttons until OK is displayed. Use the 'raise' and 'lower' buttons to cycle through:

1. SETPOINT 1 (Default 5.0)
2. SETPOINT 2 (Default 10.0)

To enter the setting mode depress and release both buttons quickly, then adjust the displayed setting using the 'raise' or 'lower' button. To return to the Set Point menu depress and release both buttons quickly. To return to the Run Mode depress and hold both buttons for 2 seconds until 'OK' is displayed.

5.2 Main Menu

To access the main menu the following sequence of button presses must be performed.

Push and hold in both buttons then:

**release 'raise', hold in both,
release 'lower', hold in both,
release 'lower', hold in both,
release 'raise', release lower**

This sequence must be performed correctly and within 10 seconds so a little practice and patience may be required. Successful entry to the main menu is indicated when setting options 1 to 22 can be scrolled through using the 'Raise' & 'Lower' buttons.

These are the main menu options, use raise and lower buttons to cycle through:

- | | |
|--------------------------|------------------------------------|
| 1. SETPOINT 1 (sec 5.1) | 12. INPUT ZERO (sec 5.8) |
| 2. SETPOINT 2 (sec 5.1) | 13. HYS 1 (sec 5.9) |
| 3. RELAY 1 (sec 5.3) | 14. HYS 2 (sec 5.9) |
| 4. RELAY 2 (sec 5.3) | 15. OUTPUT OPTIONS (sec 5.10) |
| 5. LED 1 (sec 5.4) | 16. POWER ON DELAY (sec 5.11) |
| 6. LED 2 (sec 5.4) | 17. OFF TO ON 1 (delay) (sec 5.12) |
| 7. OUTPUT SPAN (sec 5.5) | 18. ON TO OFF 1 (delay) (sec 5.13) |
| 8. OUTPUT ZERO (sec 5.5) | 19. ON DELAY 1 (sec 5.14) |
| 9. INPUT UNITS (sec 5.6) | 20. OFF TO ON 2 (delay) (sec 5.13) |
| 10. RELAY TEST (sec 5.7) | 21. ON TO OFF 2 (delay) (sec 5.13) |
| 11. INPUT SPAN (sec 5.8) | 22. ON DELAY 2 (sec 5.14) |

To access the sub menu of one of the main menu options, use raise or lower to cycle to the option required then push and release both buttons quickly. Change the parameter as required using the raise or lower buttons. To return to the main menu, push and release both buttons quickly.

To exit from the main menu and return to run mode, press and hold both buttons for 2 seconds until OK is displayed on the screen.

After two minutes of inactivity from the front buttons when the main menu (or a sub menu) had been accessed, a timeout will occur and the unit will automatically return to run mode.

In run mode, briefly pressing and releasing both buttons will scroll the input value across the display with the units. Any latched relays will also be reset.

The following sections detail the main menu functions 3 to 22.

5.3 Menu 3 & 4 - RELAY1 & RELAY2

Each relay can function in one of the following:-

RLY 1 ON ABOVE SP1	RLY 2 ON ABOVE SP2
RLY 1 OFF ABOVE SP1	RLY 2 OFF ABOVE SP2
RLY 1 ON BELOW SP1	RLY 2 OFF ABOVE SP2
RLY 1 OFF BELOW SP1	RLY 2 OFF BELOW SP2
RLY 1 LATCH ON ABOVE SP1	RLY 2 LATCH ON ABOVE SP2
RLY 1 LATCH OFF ABOVE SP1 (<i>Default</i>)	RLY 2 LATCH OFF ABOVE SP2 (<i>Default</i>)
RLY 1 LATCH ON BELOW SP1	RLY 2 LATCH ON BELOW SP2
RLY 1 LATCH OFF BELOW SP1	RLY 2 LATCH OFF BELOW SP2

Latched relays are reset by pushing & releasing both buttons together in run mode.

Non-latched relays will reset when the alarm level falls below the level set by the HYS1 and HYS2 menu items 13 and 14 for the respective relays (see section 5.9). The following two drawings show the interaction of relay and hysteresis settings.

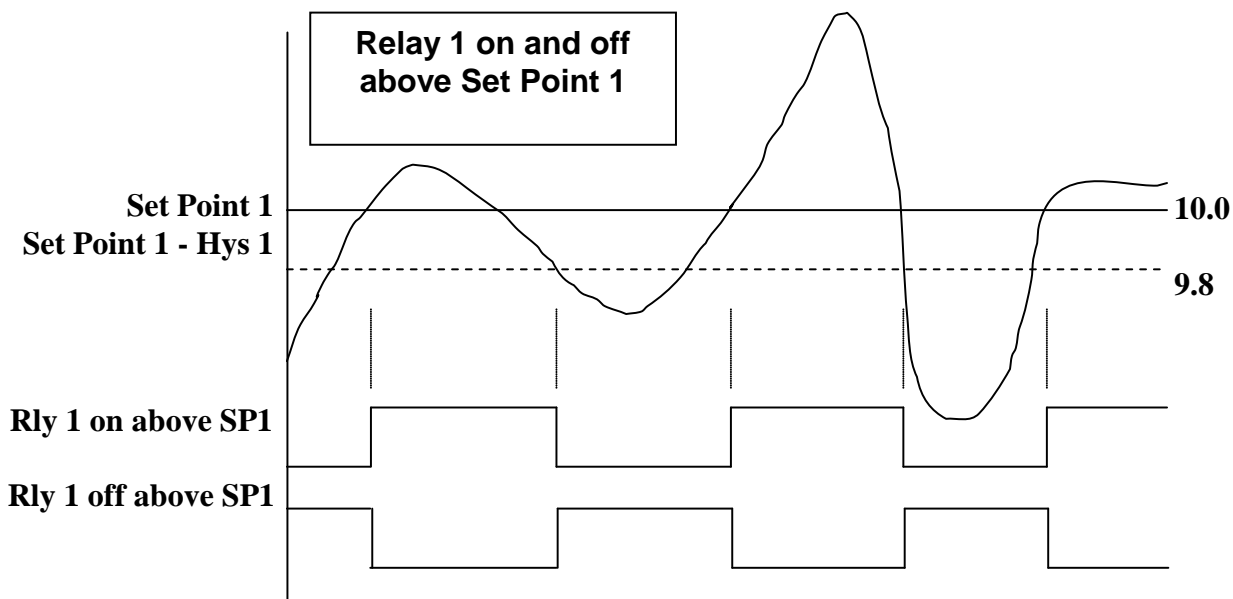

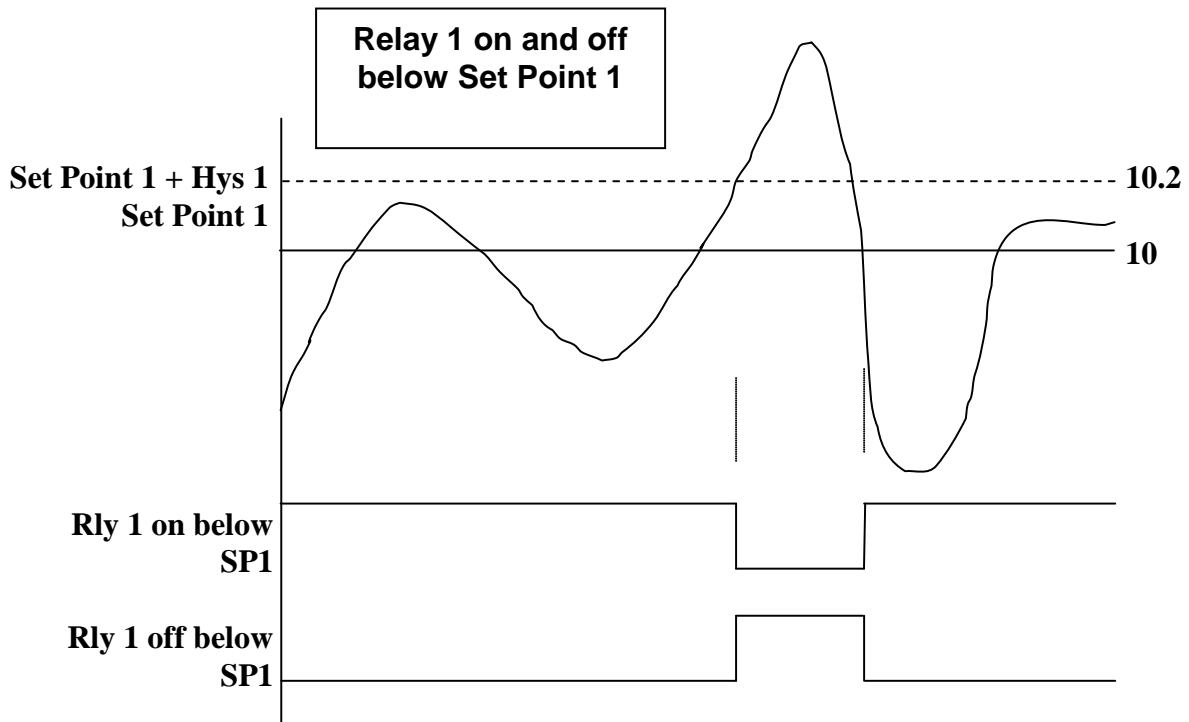

5.4 Menu 5 & 6 - LED 1 & LED 2

The LEDs on the front panel can be configured in the following ways:

- LED 1 ON WHEN RLY 1 ON
- LED 1 ON WHEN RLY 1 OFF *(Default)*
- LED 2 ON WHEN RLY 2 ON
- LED 2 ON WHEN RLY 2 OFF *(Default)*

5.5 Menu 7 & 8 – OUTPUT SPAN & OUTPUT ZERO

Setting of the zero and span points is non-interactive, so each point need only be set once. *(Default Zero: 4mA, Default Span: 20mA)*. Re-calibration of the output zero and span is performed using a digital multi-meter (DMM) connected to the output terminals. A typical calibration sequence would be as follows:

Display	Action
7.OUTPUT SPAN	Apply full scale input. Press and release both buttons together
SPAN ADJUST	Press raise/lower buttons to adjust output on DMM until correct Press and release both buttons together
7.OUTPUT SPAN	Press raise button to change main menu item to 8.OUTPUT ZERO
8.OUTPUT ZERO	Apply zero scale input Press and release both buttons together
ZERO ADJUST	Press raise/lower buttons to adjust output on DMM until correct Press and release both buttons together

5.6 Menu 9 – INPUT UNITS

The following units are available to represent the input signal.

%, mA, V, A, mV, °C, OHM, blank (Default: Blank 2DP)

The number of decimal places can be chosen, for each selected unit, to allow a bigger input range (with lower resolution) to be represented.

2 decimal places (-327.68 to 327.67) or 1 decimal place (-3276.8 to 3276.7)

5.7 Menu 10 – RELAY TEST

This option allows the relays and LEDs to be tested.

RLY 1 OFF RLY 2 OFF	(both LEDs off)
RLY 1 OFF RLY 2 ON	(just LED2 on)
RLY 1 ON RLY 2 OFF	(just LED1 on)
RLY 1 ON RLY 2 ON	(both LED on)

Note that the unit will automatically timeout after two minutes of inactivity from the front buttons, and return to run mode.

5.8 Menu 11 & 12 – INPUT SPAN & INPUT ZERO

(Default Input Span = 20.00mA, Default Input Zero = 4.00mA).

In run mode the front panel display shows the value of the input to the HS510. Values can be adjusted to correspond to the full scale and zero scale input values used when Output Span and Output Zero were adjusted.

5.9 Menu 13 & 14 - HYS1 & HYS2

(Default: 0.20)

This sets the level at which non-latched relays will reset when the vibration level falls below the alarm level. The default hysteresis is set at 0.2 which means that for an alarm level set for 'above' 10 the relay reset level is at 9.8 as shown in section 5.3.

5.10 Menu 15 – OUTPUT OPTIONS

Averaging and burnout options can be selected. To restore the default values, choose DEFAULT VALUES then press and release both buttons to return to the main menu. From that point on, all values will have returned to defaults.

AVERAGE ON HIGH BURNOUT	(Default)
AVERAGE ON LOW BURNOUT	
AVERAGE OFF HIGH BURNOUT	
AVERAGE OFF LOW BURNOUT	
DEFAULT VALUES	

5.10 Cont.

High burnout values are approximately 23mA or 11.5V.
 Low burnout values are approximately 0mA or 0V.

Averaging is carried out using the following algorithm (a weighted average of the last eight readings, with each new reading every 20 milliseconds):

$$\text{New Average} = \frac{\text{New Reading} + (7 \times \text{Old Average})}{8}$$

5.11 Menu 16 – POWER ON DELAY

After power on, relays cannot trip during this time delay. *(Default 30 seconds)*
 There are seven time delays available. The maximum values are 1310.7 seconds, with a resolution of 20 milliseconds.

5.12 Menu 17 & 20 - OFF TO ON DELAY1& OFF TO ON 2 DELAY2

The trip condition must be seen for this delay before the relay can trip *(see picture below)*.
(Default 5.0 seconds)

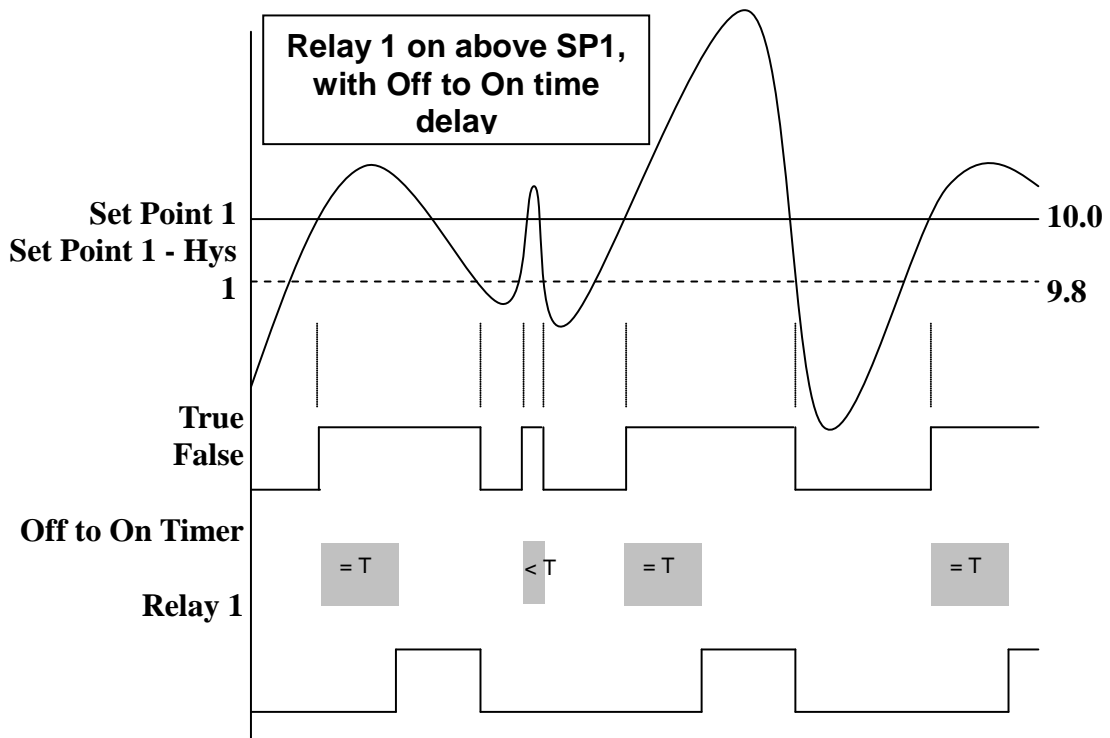

5.13 Menu 18 & 21 - ON TO OFF DELAY1 & ON TO OFF DELAY2

The trip condition must not be seen for this delay before the relay can reset (see pictures below). (*Default 0.5 seconds*)

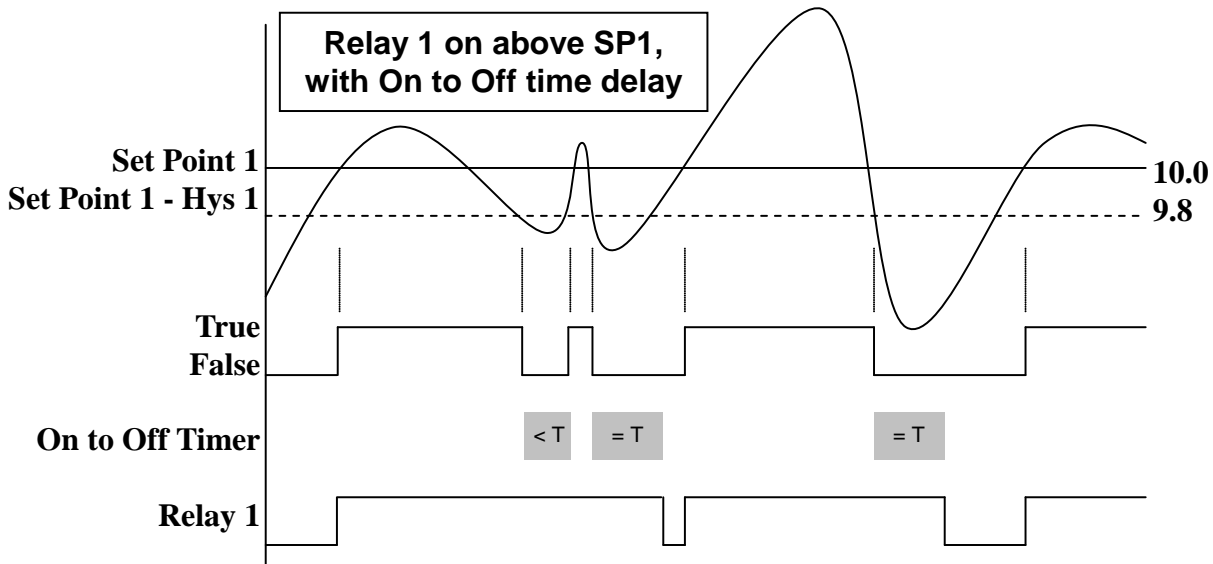

5.14 Menu 19 & 22 - ON DELAY1 & ON DELAY2

Relay must remain tripped for this delay before being allowed to reset (see picture below). (*Default 0.5 seconds*)

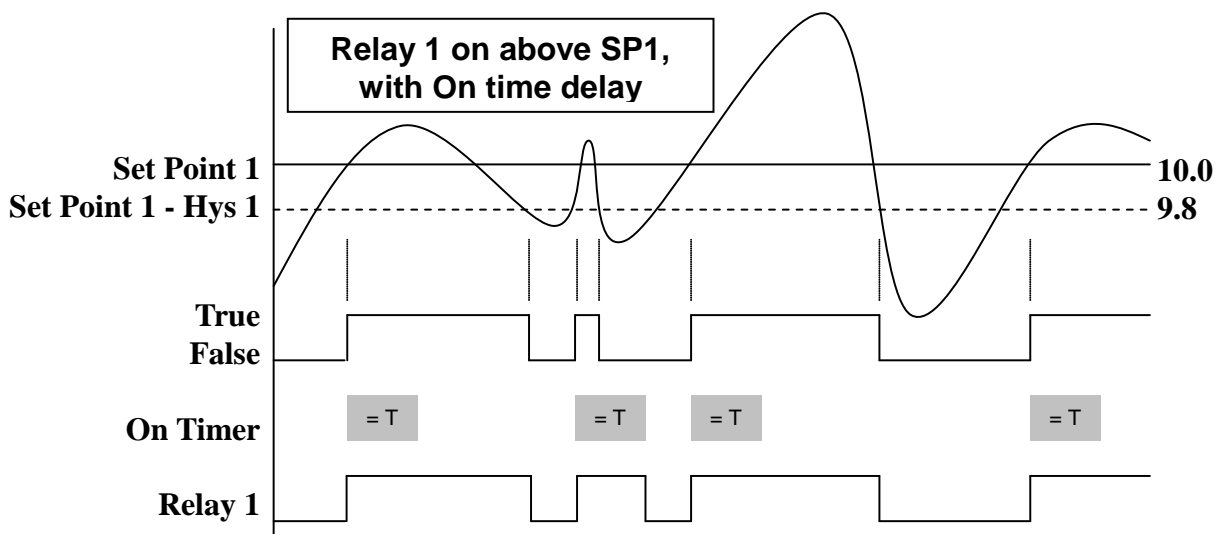

All 3 delays (or any combination) can be used at the same time if desired. Note that if the relay is tripped, both the 'on delay' timer and the 'on to off delay' timer can hold the relay in the tripped condition until both have expired (see picture below).

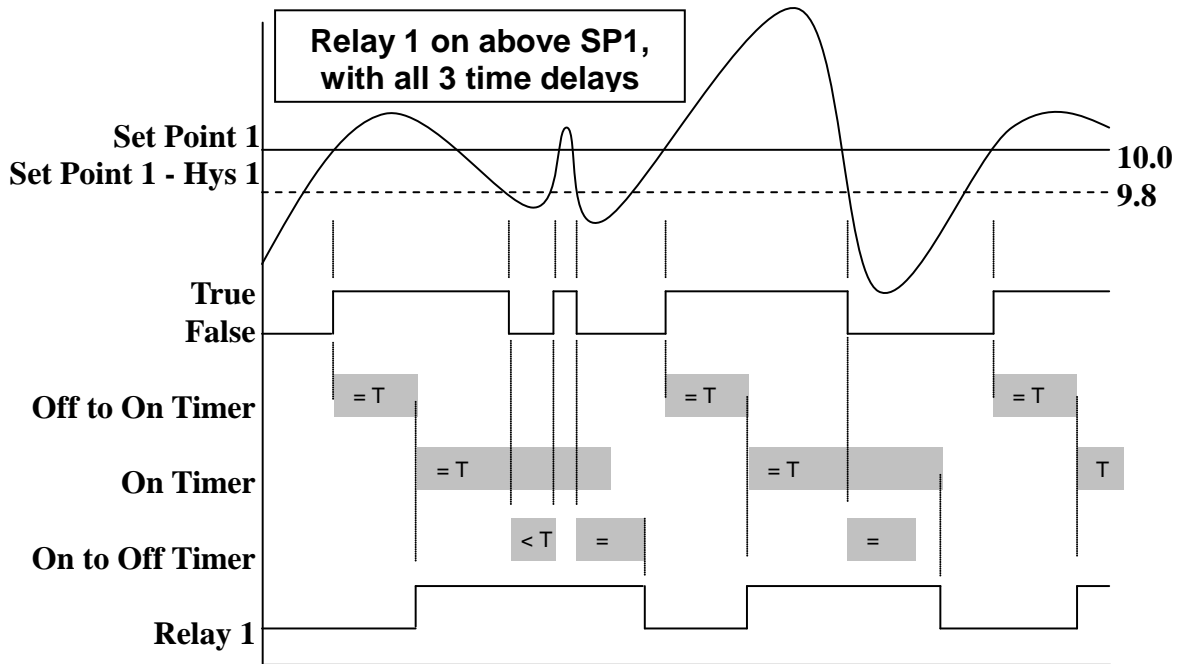

6. RE-CONFIGURING THE INPUT AND OUTPUT



! WARNING !
**DO NOT OPEN UNIT OR ADJUST SWITCHES WITH
 POWER SUPPLY, INPUT OR OUTPUT CONNECTED**

To change the input output setting from the default 4-20mA it is necessary to remove the SI-510 from its outer case. To open the SI-510, 2 catches just below the outer terminal blocks must be pushed in gently, one at a time. The front of the case can then be pulled and the unit will withdraw from the cover.

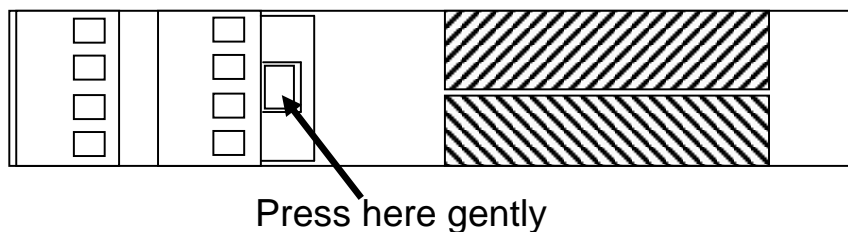

There are 2 switch banks, S1 and S2, a link L201 and a single switch S3 located inside the SI-510 as shown below:-

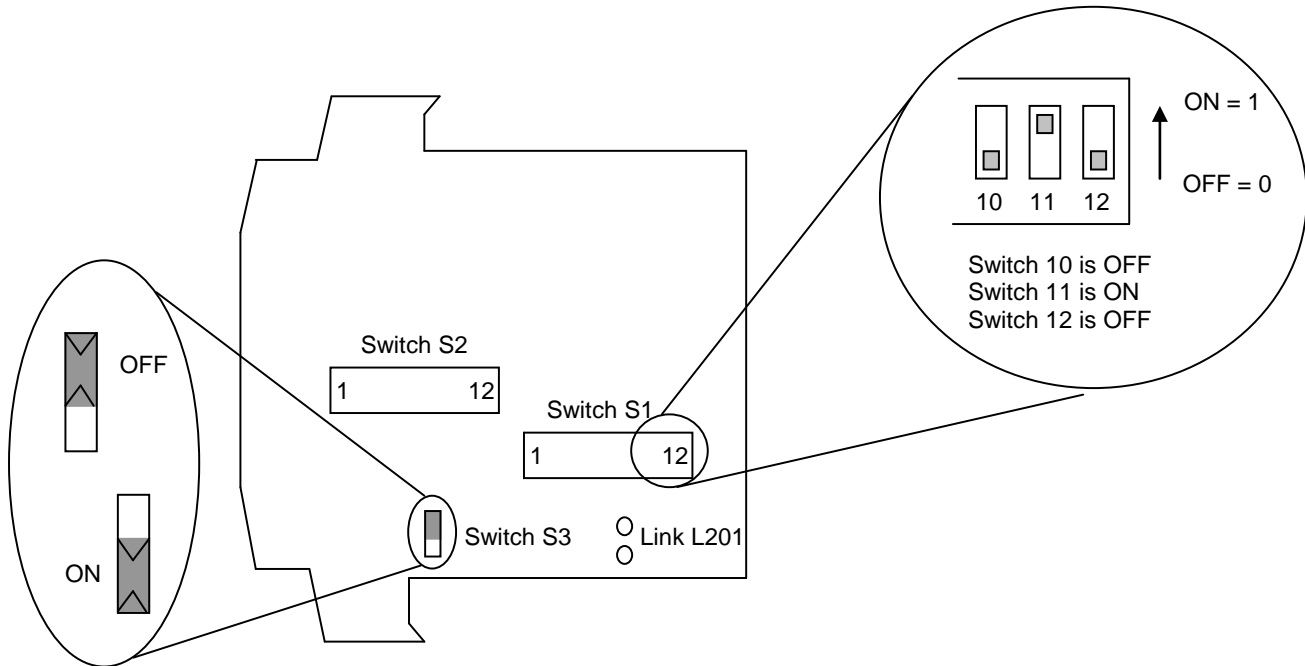

Switch S1, S2 and Link L201 configure the input type and range, and switch S3 configures the output type. Link L201 is connected only for potentiometer inputs which are not considered in this manual. The switch settings are explained in the next few pages. The diagrams refer to switch positions 0 and 1, with 0 being OFF and 1 being ON. This is illustrated in the picture above.

6.1 Set Voltage Input:

Select the range from the table below and set Switch S1 to the required values.

Voltage Range	Switch S1											
	1	2	3	4	5	6	7	8	9	10	11	12
0-1V	0	0	0	0	0	1	0	0	1	1	0	0
0-2V	0	0	0	1	}							0
0-4V	0	0	1	0	}							0
0-5V	0	1	0	0	}							0
0-7.5V	1	0	0	0	}							0
0-8V	0	0	1	1	}							0
0-10V	0	1	0	1	}							0
0-15V	1	0	0	1	}							0
0-20V	0	1	1	0	}							0
0-30V	1	0	1	0	}							0
0-40V	0	1	1	1	}							0
1-5V	0	1	0	0	}							1
-5 to +5V	1	1	0	0	}							1
-10 to +10V	1	1	0	1	0	1	0	0	1	1	0	0

Then select the required setting from the table below for switch S2.

Voltage Range	Switch S2											
	1	2	3	4	5	6	7	8	9	10	11	12
0-30V & 0-40V Ranges	0	0	1	1	0	0	1	1	0	0	0	0
All other Ranges Listed Above	0	0	1	0	1	0	1	0	0	0	0	0

6.2 Set Current Input

Select the range from the table below and set Switch S1 to the required values.

mA Range	Switch S1											
	1	2	3	4	5	6	7	8	9	10	11	12
0-1mA	0	0	0	0	0	0	0	0	1	1	1	0
0-2mA	0	0	0	1								0
0-4mA	0	0	1	0								0
0-5mA	0	1	0	0								0
0-8mA	0	0	1	1								0
0-10mA	0	1	0	1								0
0-15mA	1	0	0	1								0
0-20mA	0	1	1	0								0
0-30mA	1	0	1	0								0
4-20mA	0	1	1	0								1
4-40mA	0	1	1	1								1
4-30mA	1	0	1	0	1							
-5 to +5mA	1	1	0	0	0	0	0	1	1	1	0	
-10 to +10mA	1	1	0	1	0	0	0	0	1	1	1	0

Then select the required setting from the table below for switch S2.

mA Range	Switch S2											
	1	2	3	4	5	6	7	8	9	10	11	12
Using Internal 24V Tx Supply for 4 to 20mA transmitter	1	1	0	1	0	0	1	1	0	0	1	0
Unipolar Ranges (e.g. 0-20mA, 4-20mA)	1	1	0	0	0	0	1	1	0	0	0	0
Bipolar Ranges (e.g. -10 to +10mA)	1	1	0	0	1	0	1	0	0	0	0	0



! WARNING !
DO NOT OPEN UNIT OR ADJUST SWITCHES WITH POWER SUPPLY, INPUT OR OUTPUT CONNECTED

6.3 SI-510 Error Messages

The SI-510 has some built in self diagnostic functions. Errors encountered will be displayed on screen.

BURNOUT ERROR Refers only to RTD or Thermocouple inputs.

EEPROM ERROR Stored data has been corrupted. Push and release both buttons then recalibrate the output and reset all the required options and values.

<p>NO DATA ERROR PARITY ERROR ADC ERROR CJC ERROR</p>	}	<p>Switch off unit, check switch settings and wiring, then re-try. If still faulty please contact supplier.</p>
--	---	---

7. SI-510 SPECIFICATIONS (@ 25°C)

Operating Temperature.....	0 to 55 °C
Operating Altitude	Sea Level to 2000m
Humidity.....	0-90% RH
Power Requirements.....	DC Supply 16 to 30VDC AC Supply 16 to 32VDC
Current Consumption	55mA @ 24VDC (20mA in & out) 90mA as above with both relays & LEDs on 85mA @ 24VDC (maximum load, TX supply) 120mA as above with both relays & LEDs on 260mA for 50ms on 24VDC power up
Transmitter Power Supply	22V to 29V @ up to 24mA dependent on supply voltage and load
Calibration accuracy	±0.05% full scale
Linearity.....	±0.05% full scale
Temperature Stability	50ppm / °C
Input Impedance:	Current Input 15Ω Voltage Input 1 MΩ
Millivolt Input.....	> 10MΩ
Maximum Voltage Output.....	11.5 V into a minimum of 7kΩ
Maximum Current Output	23.0 mA into a maximum of 1kΩ
Time Response (90% of step change):	50ms ± 10ms
Isolation	Full 3 port isolation to 1kV between Power Supply Input and Output.
Transient Withstand.....	2.5kV for 50 μsec.
Dimensions	114.5 mm x 99mm x 22.5mm (H x D x W)
Mounting	DIN Rail TS35
Connections	Screw Clamp with pressure plate
Conductor Size	0.5 to 4.0 mm
Insulation Stripping	12 mm
Maximum Terminal Torque	0.4 Nm
Weight	Approx. 140g
EMC Emissions	EN50081-1:1992, EN50081-2:1993
EMC Immunity.....	EN50082-1:1997
LVD Standards	EN61010-1:1993
Installation Category.....	(IEC 664)II
Pollution Degree (EN61010-1:1993).....	2
Equipment Class (IEC 536).....	II
Mains Rated Relays	3A resistive at 240VAC

8. WARRANTY

All goods are guaranteed against defects in materials and workmanship, subject to specific exclusions, for a period of 36 months from the date of purchase. In the event of failure within 36 months of original purchase, the company will promptly repair or replace the defective components without charge.

Specific exceptions rendering the Warranty void are:-

If repair is attempted by unauthorised persons or agents, or if the product has been used for purposes for which it was not intended and or subjected to abuse or wilful neglect. No liability can be accepted for loss of items or component parts. It is expected that the user takes sufficient precautions to safeguard all guaranteed items.

Whilst every effort has been taken to ensure the accuracy of this document, we accept no responsibility for damage, injury, loss or expense resulting from errors or omissions, and reserve the right of amendment without notice.

This document may not be reproduced in any way without the prior written permission of the company.

Spectrum Instruments Ltd.

Spectrum Instruments Ltd
44 Forest Drive
Brighton, Ontario K0K 1H0
Canada
P: 1-613-439-8767 F: 1-866-782-0106
www.spectrum-instruments.com